

CONNECTION

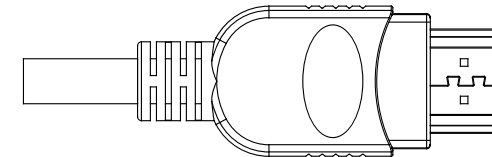
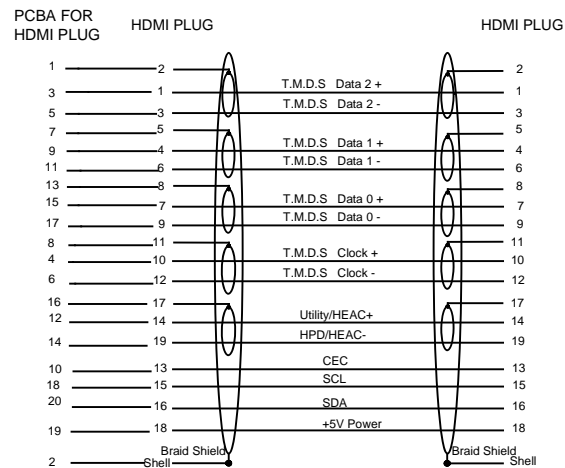
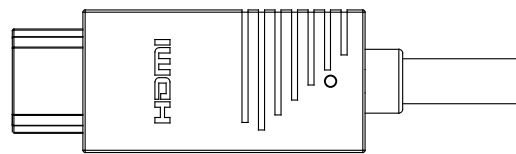

ITEM	SPECIFICATION
4	UL20276 {[(7/0.10Tc+F.PE)*1P+7/0.10Tc+AL/Mylar]*5+ (7/0.10Tc+PE)*4C+FILLER+AL.F+16/10/0.10Tc 85%}*1C OD=6.0±0.15MM Jacket=Black PVC With White Marking:High Speed HDMI® Cable With Ethernet UL AWM 20276 VW-1 80°C 30V E81280-D CHING TAI (307187101200000B)
3	PVC - Black 50P(ABS&PS Non-Migration)(YT-1718/1323-A)
2	HDMI Plug - Gold Plated (303370069GB)
1	HDMI Plug - Gold Plated with RM

	<p>TOLERANCES UNLESS OTHERWISE STATED</p> <p>X. = ± 1</p> <p>.X = ± 0.2</p> <p>.XX = ± 0.1</p>
--	--

P/N:	HAM/AE7MJ	REVISION	A
DESCRIPTION	HDMI Active Cable w/HEAC 7M #30 OD:6.0mm	UNIT	mm
		SCALE	NO
		PAGE NO	1/1
		DATE	2015.09.04
JAPAN MATERIAL Co.,Ltd.			

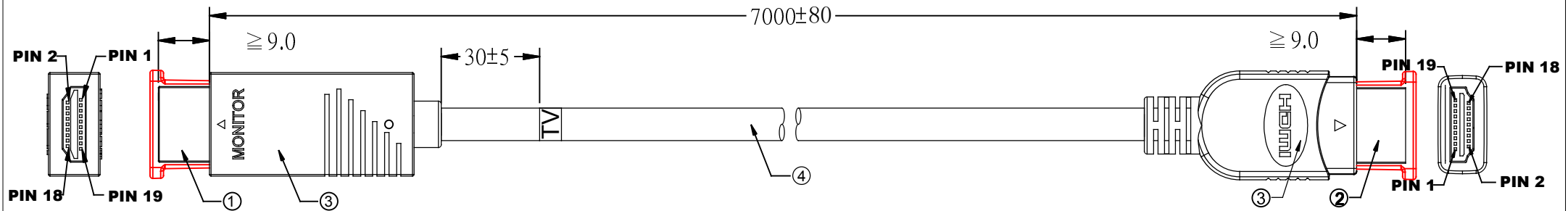

CONNECTION

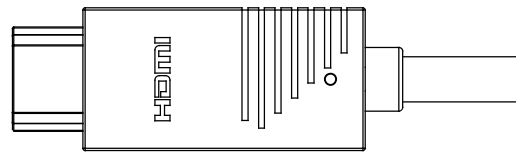

PCBA FOR
HDMI PLUG

HDMI PLUG

HDMI PLUG

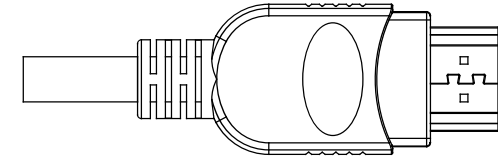
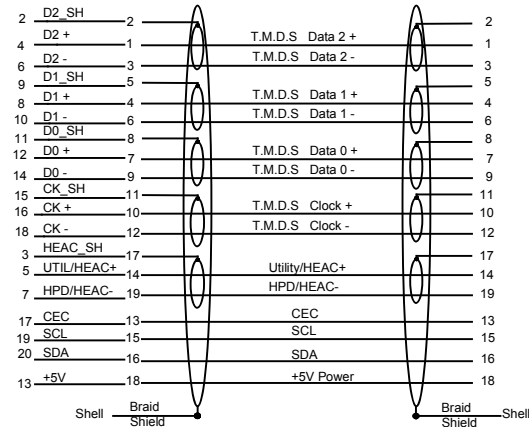

4	UL20276 {[(7/0.10Tc+F.PE)*1P+7/0.10Tc+AL/Mylar]*5+ (7/0.10Tc+PE)*4C+FILLER+AL.F+16/10/0.10Tc 85%}*1C OD=6.0±0.15MM Jacket=Black PVC With White Marking:High Speed HDMI® Cable With Ethernet UL AWM 20276 VW-1 80°C 30V E81280-D CHING TAI (307187101200000B)
3	PVC - Black 50P(ABS&PS Non-Migration)(YT-1718/1323-A)
2	HDMI Plug - Gold Plated (303370053GB)
1	HDMI Plug - Gold Plated with PRA
ITEM	SPECIFICATION

TOLERANCES UNLESS OTHERWISE STATED	
X.	= ± 1
.X	= ± 0.2
.XX	= ± 0.1

P / N	HAM/AE7M
DESCRIPTION	HDMI Active Cable w/HEAC 7M OD:6.0mm

REVISION	A
UNIT	mm
SCALE	NO
PAGE NO	1/1
DATE	2015.1.22